

LM7121

235 MHz Tiny Low Power Voltage Feedback Amplifier

General Description

The LM7121 is a high performance operational amplifier which addresses the increasing AC performance needs of video and imaging applications, and the size and power constraints of portable applications.

The LM7121 can operate over a wide dynamic range of supply voltages, from 5V (single supply) up to $\pm 15V$ (see the Application Information section for more details). It offers an excellent speed-power product delivering $1300V/\mu s$ and 235 MHz Bandwidth (-3 dB , $A_V = +1$). Another key feature of this operational amplifier is stability while driving unlimited capacitive loads.

Due to its Tiny SOT23-5 package, the LM7121 is ideal for designs where space and weight are the critical parameters. The benefits of the Tiny package are evident in small portable electronic devices, such as cameras, and PC video cards. Tiny amplifiers are so small that they can be placed anywhere on a board close to the signal source or near the input to an A/D converter.

Features

(Typical unless otherwise noted) $V_S = \pm 15V$

- Easy to use voltage feedback topology
- Stable with unlimited capacitive loads
- Tiny SOT23-5 package — typical circuit layout takes half the space of SO-8 designs
- Unity gain frequency: 175 MHz
- Bandwidth (-3 dB , $A_V = +1$, $R_L = 100\Omega$): 235 MHz
- Slew rate: $1300V/\mu s$
- Supply Voltages SO-8: 5V to $\pm 15V$
SOT23-5: 5V to $\pm 5V$
- Characterized for: $+5V$, $\pm 5V$, $\pm 15V$
- Low supply current: 5.3 mA

Applications

- Scanners, color fax, digital copiers
- PC video cards
- Cable drivers
- Digital cameras
- ADC/DAC buffers
- Set-top boxes

Connection Diagrams

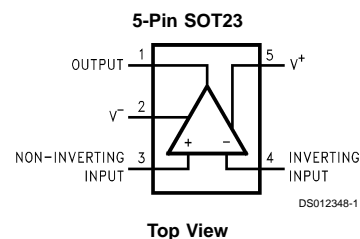
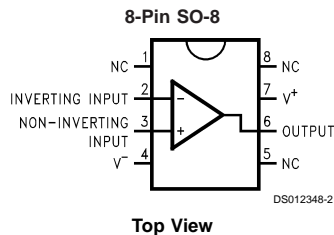

Ordering Information

Package	Ordering Information	NSC Drawing Number	Package Marking	Supplied As
8-Pin SO-8	LM7121IM	M08A	LM7121IM	Rails
	LM7121IMX	M08A	LM7121IM	2.5k Tape and Reel
5-Pin SOT23-5	LM7121IM5	MA05A	A03A	1k Tape and Reel
	LM7121IM5X	MA05A	A03A	3k Tape and Reel

Absolute Maximum Ratings (Note 1)

If Military/Aerospace specified devices are required, please contact the National Semiconductor Sales Office/Distributors for availability and specifications.

ESD Tolerance (Note 2)	2000V
Differential Input Voltage (Note 7)	±2V
Voltage at Input/Output Pin	(V ⁺)−1.4V, (V [−]) +1.4V
Supply Voltage (V ⁺ −V [−])	36V
Output Short Circuit to Ground (Note 3)	Continuous
Lead Temperature	260°C
(soldering, 10 sec)	260°C

Storage Temperature Range	−65°C to +150°C
Junction Temperature (Note 4)	150°C

Operating Ratings (Note 1)

Supply Voltage: SO-8	4.5V ≤ V _S ≤ 33V
SOT23-5	4.5V ≤ V _S ≤ 11V
Junction Temperature Range	−40°C ≤ T _J ≤ +85°C
Thermal Resistance (θ _{JA})	
M Package, 8-pin Surface Mount	165°C/W
SOT23-5 Package	325°C/W

±15V DC Electrical Characteristics

Unless otherwise specified, all limits guaranteed for T_J = 25°C, V⁺ = +15V, V[−] = −15V, V_{CM} = V_O = 0V and R_L > 1 MΩ. **Boldface** limits apply at the temperature extremes.

Symbol	Parameter	Conditions	Typ (Note 5)	LM71211 Limit (Note 6)	Units
V _{OS}	Input Offset Voltage		0.9	8 15	mV max
I _B	Input Bias Current		5.2	9.5 12	μA max
I _{OS}	Input Offset Current		0.04	4.3 7	μA max
R _{IN}	Input Resistance	Common Mode	10		MΩ
		Differential Mode	3.4		MΩ
C _{IN}	Input Capacitance	Common Mode	2.3		pF
CMRR	Common Mode Rejection Ratio	−10V ≤ V _{CM} ≤ 10V	93	73 70	dB min
+PSRR	Positive Power Supply Rejection Ratio	10V ≤ V ⁺ ≤ 15V	86	70 68	dB min
−PSRR	Negative Power Supply Rejection Ratio	−15V ≤ V [−] ≤ −10V	81	68 65	dB min
V _{CM}	Input Common-Mode Voltage Range	CMRR ≥ 70 dB	13	11	V min
			−13	−11	V max
A _V	Large Signal Voltage Gain	R _L = 2 kΩ, V _O = 20 V _{PP}	72	65 57	dB min
V _O	Output Swing	R _L = 2 kΩ	13.4	11.1 10.8	V min
			−13.4	−11.2 −11.0	V max
		R _L = 150Ω	10.2	7.75 7.0	V min
			−7.0	−5.0 −4.8	V max
I _{SC}	Output Short Circuit Current	Sourcing	71	54 44	mA min
		Sinking	52	39 34	mA min

±15V DC Electrical Characteristics (Continued)

Unless otherwise specified, all limits guaranteed for $T_J = 25^\circ\text{C}$, $V^+ = +15\text{V}$, $V^- = -15\text{V}$, $V_{\text{CM}} = V_O = 0\text{V}$ and $R_L > 1\text{ M}\Omega$. **Boldface** limits apply at the temperature extremes.

Symbol	Parameter	Conditions	Typ (Note 5)	LM71211 Limit (Note 6)	Units
I_S	Supply Current		5.3	6.6 7.5	mA max

±15V AC Electrical Characteristics

Unless otherwise specified, all limits guaranteed for $T_J = 25^\circ\text{C}$, $V^+ = 15\text{V}$, $V^- = -15\text{V}$, $V_{\text{CM}} = V_O = 0\text{V}$ and $R_L > 1\text{ M}\Omega$. **Boldface** limits apply at the temperature extremes.

Symbol	Parameter	Conditions	Typ (Note 5)	LM71211 Limit (Note 6)	Units
SR	Slew Rate (Note 8)	$A_V = +2$, $R_L = 1\text{ k}\Omega$, $V_O = 20 V_{\text{PP}}$	1300		V/ μs
GBW	Unity Gain-Bandwidth	$R_L = 1\text{ k}\Omega$	175		MHz
ϕ_m	Phase Margin		63		Deg
f (-3 dB)	Bandwidth (Notes 9, 10)	$R_L = 100\Omega$, $A_V = +1$ $R_L = 100\Omega$, $A_V = +2$	235 50		MHz
t_s	Settling Time	10 V_{PP} Step, to 0.1%, $R_L = 500\Omega$	74		ns
t_r , t_f	Rise and Fall Time (Note 10)	$A_V = +2$, $R_L = 100\Omega$, $V_O = 0.4 V_{\text{PP}}$	5.3		ns
A_D	Differential Gain	$A_V = +2$, $R_L = 150\Omega$	0.3		%
ϕ_D	Differential Phase	$A_V = +2$, $R_L = 150\Omega$	0.65		Deg
e_n	Input-Referred Voltage Noise	$f = 10\text{ kHz}$	17		$\frac{\text{nV}}{\sqrt{\text{Hz}}}$
i_n	Input-Referred Current Noise	$f = 10\text{ kHz}$	1.9		$\frac{\text{pA}}{\sqrt{\text{Hz}}}$
T.H.D.	Total Harmonic Distortion	2 V_{PP} Output, $R_L = 150\Omega$, $A_V = +2$, $f = 1\text{ MHz}$ 2 V_{PP} Output, $R_L = 150\Omega$, $A_V = +2$, $f = 5\text{ MHz}$	0.065 0.52		%

±5V DC Electrical Characteristics

Unless otherwise specified, all limits guaranteed for $T_J = 25^\circ\text{C}$, $V^+ = 5\text{V}$, $V^- = -5\text{V}$, $V_{\text{CM}} = V_O = 0\text{V}$ and $R_L > 1\text{ M}\Omega$. **Boldface** limits apply at the temperature extremes.

Symbol	Parameter	Conditions	Typ (Note 5)	LM71211 Limit (Note 6)	Units
V_{OS}	Input Offset Voltage		1.6	8 15	mV max
I_B	Input Bias Current		5.5	9.5 12	μA max
I_{OS}	Input Offset Current		0.07	4.3 7.0	μA max
R_{IN}	Input Resistance	Common Mode	6.8		$\text{M}\Omega$
		Differential Mode	3.4		$\text{M}\Omega$

±5V DC Electrical Characteristics (Continued)

Unless otherwise specified, all limits guaranteed for $T_J = 25^\circ\text{C}$, $V^+ = 5\text{V}$, $V^- = -5\text{V}$, $V_{\text{CM}} = V_O = 0\text{V}$ and $R_L > 1\text{M}\Omega$. **Bold-face** limits apply at the temperature extremes.

Symbol	Parameter	Conditions	Typ (Note 5)	LM71211 Limit (Note 6)	Units
C_{IN}	Input Capacitance	Common Mode	2.3		pF
CMRR	Common Mode Rejection Ratio	$-2\text{V} \leq V_{\text{CM}} \leq 2\text{V}$	75	65	dB
				60	min
+PSRR	Positive Power Supply Rejection Ratio	$3\text{V} \leq V^+ \leq 5\text{V}$	89	65 60	dB min
-PSRR	Negative Power Supply Rejection Ratio	$-5\text{V} \leq V^- \leq -3\text{V}$	78	65 60	dB min
V_{CM}	Input Common Mode Voltage Range	CMRR $\geq 60\text{ dB}$	3	2.5	V min
			-3	-2.5	V max
A_V	Large Signal Voltage Gain	$R_L = 2\text{ k}\Omega$, $V_O = 3\text{ V}_{\text{PP}}$	66	60 58	dB min
V_O	Output Swing	$R_L = 2\text{ k}\Omega$	3.62	3.0 2.75	V min
			-3.62	-3.0 -2.70	V max
		$R_L = 150\Omega$	3.1	2.5 2.3	V min
			-2.8	-2.15 -2.00	V max
I_{SC}	Output Short Circuit Current	Sourcing	53	38 33	mA min
		Sinking	29	21 19	mA min
I_S	Supply Current		5.1	6.4 7.2	mA max

±5V AC Electrical Characteristics

Unless otherwise specified, all limits guaranteed for $T_J = 25^\circ\text{C}$, $V^+ = 5\text{V}$, $V^- = -5\text{V}$, $V_{\text{CM}} = V_O = 0\text{V}$ and $R_L > 1\text{M}\Omega$. **Bold-face** limits apply at the temperature extremes.

Symbol	Parameter	Conditions	Typ (Note 5)	LM71211 Limit (Note 6)	Units
SR	Slew Rate (Note 8)	$A_V = +2$, $R_L = 1\text{ k}\Omega$, $V_O = 6\text{ V}_{\text{PP}}$	520		V/ μs
GBW	Unity Gain-Bandwidth	$R_L = 1\text{ k}\Omega$	105		MHz
ϕ_m	Phase Margin	$R_L = 1\text{ k}\Omega$	74		Deg
f (-3 dB)	Bandwidth (Notes 9, 10)	$R_L = 100\Omega$, $A_V = +1$	160		MHz
		$R_L = 100\Omega$, $A_V = +2$	50		
t_s	Settling Time	5 V_{PP} Step, to 0.1%, $R_L = 500\Omega$	65		ns
t_r , t_f	Rise and Fall Time (Note 10)	$A_V = +2$, $R_L = 100\Omega$, $V_O = 0.4\text{ V}_{\text{PP}}$	5.8		ns
A_D	Differential Gain	$A_V = +2$, $R_L = 150\Omega$	0.3		%

±5V AC Electrical Characteristics (Continued)

Unless otherwise specified, all limits guaranteed for $T_J = 25^\circ\text{C}$, $V^+ = 5\text{V}$, $V^- = -5\text{V}$, $V_{\text{CM}} = V_O = 0\text{V}$ and $R_L > 1\text{M}\Omega$. **Bold-face** limits apply at the temperature extremes.

Symbol	Parameter	Conditions	Typ (Note 5)	LM71211 Limit (Note 6)	Units
ϕ_D	Differential Phase	$A_V = +2$, $R_L = 150\Omega$	0.65		Deg
e_n	Input-Referred Voltage Noise	$f = 10\text{kHz}$	17		$\frac{\text{nV}}{\sqrt{\text{Hz}}}$
i_n	Input-Referred Current Noise	$f = 10\text{kHz}$	2		$\frac{\text{pA}}{\sqrt{\text{Hz}}}$
T.H.D.	Total Harmonic Distortion	2 V_{PP} Output, $R_L = 150\Omega$, $A_V = +2$, $f = 1\text{MHz}$	0.1		%
		2 V_{PP} Output, $R_L = 150\Omega$, $A_V = +2$, $f = 5\text{MHz}$	0.6		

+5V DC Electrical Characteristics

Unless otherwise specified, all limits guaranteed for $T_J = 25^\circ\text{C}$, $V^+ = +5\text{V}$, $V^- = 0\text{V}$, $V_{\text{CM}} = V_O = V^+/2$ and $R_L > 1\text{M}\Omega$. **Bold-face** limits apply at the temperature extremes.

Symbol	Parameter	Conditions	Typ (Note 5)	LM71211 Limit (Note 6)	Units
V_{OS}	Input Offset Voltage		2.4		mV
I_B	Input Bias Current		4		μA
I_{OS}	Input Offset Current		0.04		μA
R_{IN}	Input Resistance	Common Mode	2.6		$\text{M}\Omega$
		Differential Mode	3.4		$\text{M}\Omega$
C_{IN}	Input Capacitance	Common Mode	2.3		pF
CMRR	Common Mode Rejection Ratio	$2\text{V} \leq V_{\text{CM}} \leq 3\text{V}$	65		dB
+PSRR	Positive Power Supply Rejection Ratio	$4.6\text{V} \leq V^+ \leq 5\text{V}$	85		dB
-PSRR	Negative Power Supply Rejection Ratio	$0\text{V} \leq V^- \leq 0.4\text{V}$	61		dB
V_{CM}	Input Common-Mode Voltage Range	CMRR $\geq 45\text{dB}$	3.5		V min
			1.5		V max
A_V	Large Signal Voltage Gain	$R_L = 2\text{k}\Omega$ to $V^+/2$	64		dB
V_O	Output Swing	$R_L = 2\text{k}\Omega$ to $V^+/2$, High	3.7		V
		$R_L = 2\text{k}\Omega$ to $V^+/2$, Low	1.3		
		$R_L = 150\Omega$ to $V^+/2$, High	3.48		
		$R_L = 150\Omega$ to $V^+/2$, Low	1.59		
I_{SC}	Output Short Circuit Current	Sourcing	33		mA
		Sinking	20		mA
I_S	Supply Current		4.8		mA

+5V AC Electrical Characteristics

Unless otherwise specified, all limits guaranteed for $T_J = 25^\circ\text{C}$, $V^+ = +5\text{V}$, $V^- = 0\text{V}$, $V_{\text{CM}} = V_O = V^+/2$ and $R_L > 1\text{M}\Omega$. **Bold-face** limits apply at the temperature extremes.

Symbol	Parameter	Conditions	Typ (Note 5)	LM7121I Limit (Note 6)	Units
SR	Slew Rate (Note 8)	$A_V = +2$, $R_L = 1\text{ k}\Omega$ to $V^+/2$, $V_O = 1.8 V_{\text{PP}}$	145		V/ μs
GBW	Unity Gain-Bandwidth	$R_L = 1\text{ k}\Omega$ to $V^+/2$	80		MHz
ϕ_m	Phase Margin	$R_L = 1\text{ k}\Omega$ to $V^+/2$	70		Deg
f (-3 dB)	Bandwidth (Notes 9, 10)	$R_L = 100\Omega$ to $V^+/2$, $A_V = +1$	200		MHz
		$R_L = 100\Omega$ to $V^+/2$, $A_V = +2$	45		
t_r , t_f	Rise and Fall Time (Note 10)	$A_V = +2$, $R_L = 100\Omega$, $V_O = 0.2 V_{\text{PP}}$	8		ns
T.H.D.	Total Harmonic Distortion	0.6 V_{PP} Output, $R_L = 150\Omega$, $A_V = +2$, $f = 1\text{ MHz}$	0.067		%
		0.6 V_{PP} Output, $R_L = 150\Omega$, $A_V = +2$, $f = 5\text{ MHz}$	0.33		

Note 1: Absolute Maximum Ratings indicate limits beyond which damage to the device may occur. Operating Ratings indicate conditions for which the device is intended to be functional, but specific performance is not guaranteed. For guaranteed specifications and the test conditions, see the Electrical Characteristics.

Note 2: Human body model, 1.5 k Ω in series with 100 pF.

Note 3: Applies to both single-supply and split-supply operation. Continuous short circuit operation at elevated ambient temperature can result in exceeding the maximum allowed junction temperature of 150°C.

Note 4: The maximum power dissipation is a function of $T_{\text{J(max)}}$, θ_{JA} , and T_A . The maximum allowable power dissipation at any ambient temperature is $P_D = (T_{\text{J(max)}} - T_A) / \theta_{\text{JA}}$. All numbers apply for packages soldered directly into a PC board.

Note 5: Typical Values represent the most likely parametric norm.

Note 6: All limits are guaranteed by testing or statistical analysis.

Note 7: Differential input voltage is measured at $V_S = \pm 15\text{V}$.

Note 8: Slew rate is the average of the rising and falling slew rates.

Note 9: Unity gain operation for $\pm 5\text{V}$ and $\pm 15\text{V}$ supplies is with a feedback network of 510 Ω and 3 pF in parallel (see the Application Information section). For +5V single supply operation, feedback is a direct short from the output to the inverting input.

Note 10: $A_V = +2$ operation with 2 k Ω resistors and 2 pF capacitor from summing node to ground.

Typical Performance Characteristics $T_A = 25^\circ\text{C}$, $R_L = 1\text{M}\Omega$. unless otherwise specified

Supply Current vs Supply Voltage

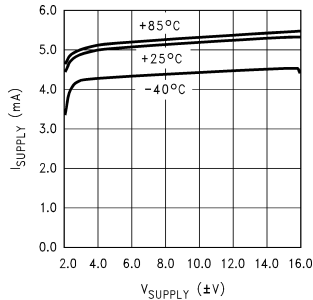

Supply Current vs Temperature

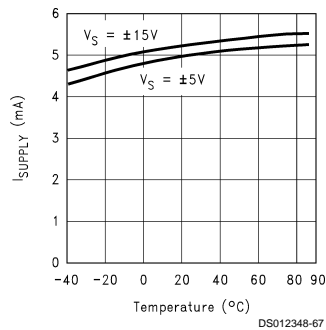

Input Offset Voltage vs Temperature

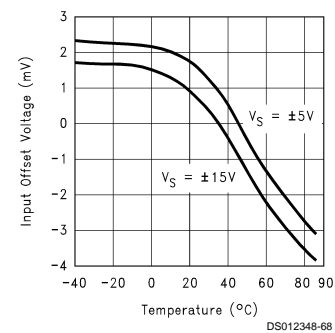

Typical Performance Characteristics $T_A = 25^\circ\text{C}$, $R_L = 1\text{ M}\Omega$, unless otherwise specified (Continued)

Input Bias Current vs Temperature

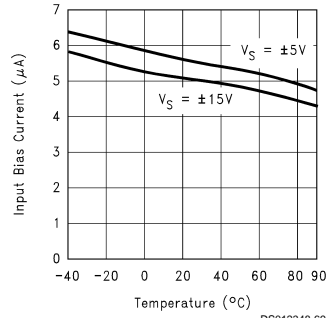

Input Offset Voltage vs Common Mode Voltage @ $V_S = \pm 15\text{V}$

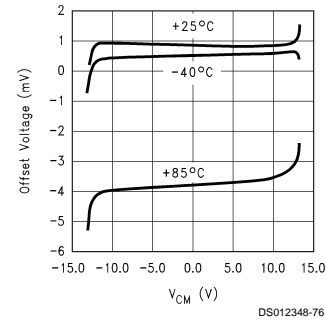

Input Offset Voltage vs Common Mode Voltage @ $V_S = \pm 5\text{V}$

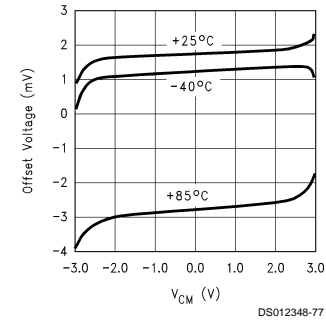

Short Circuit Current vs Temperature (Sourcing)

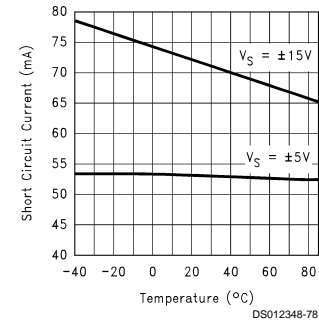

Short Circuit Current vs Temperature (Sinking)

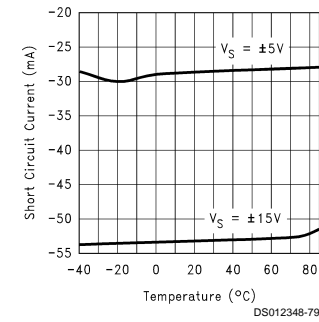

Output Voltage vs Output Current (I_{SINK} , $V_S = \pm 15\text{V}$)

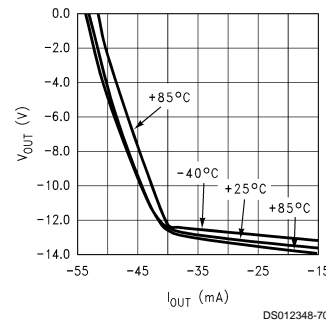

Output Voltage vs Output Current (I_{SOURCE} , $V_S = \pm 15\text{V}$)

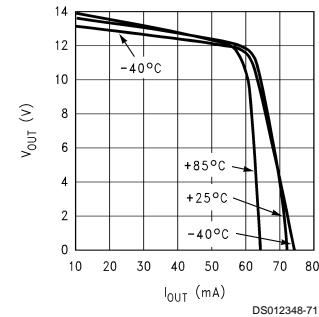

Output Voltage vs Output Current (I_{SOURCE} , $V_S = \pm 5\text{V}$)

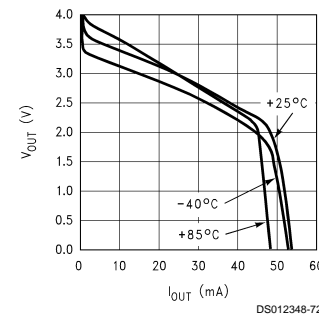

Output Voltage vs Output Current (I_{SINK} , $V_S = \pm 5\text{V}$)

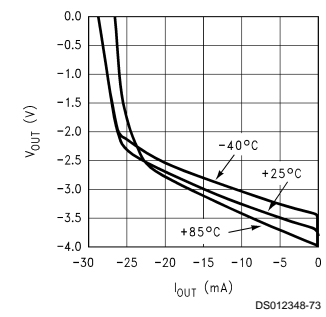

Typical Performance Characteristics $T_A = 25^\circ\text{C}$, $R_L = 1\text{ M}\Omega$, unless otherwise specified (Continued)

Output Voltage vs Output Current (I_{SOURCE} , $V_S = +5\text{V}$)

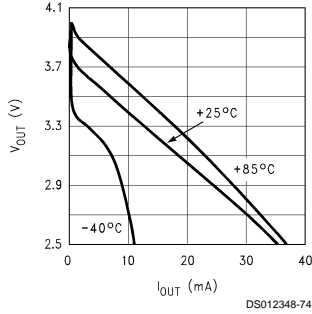

Output Voltage vs Output Current (I_{SINK} , $V_S = +5\text{V}$)

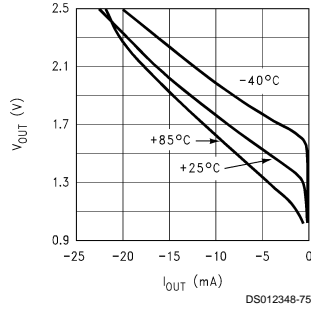

CMRR vs Frequency

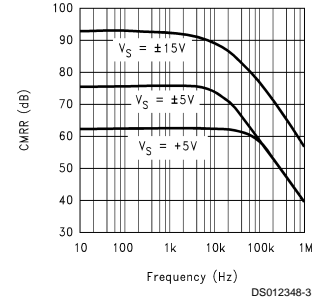

PSRR vs Frequency

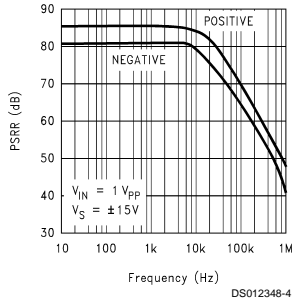

PSRR vs Frequency

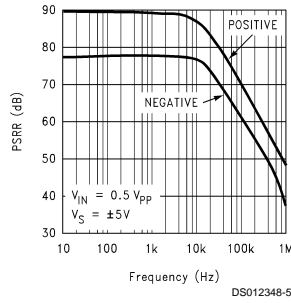

Open Loop Frequency Response

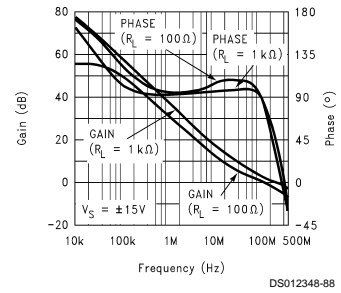

Open Loop Frequency Response

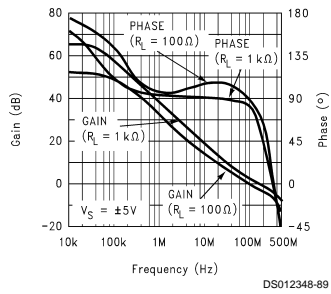

Open Loop Frequency Response

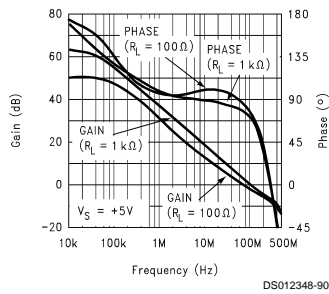

Unity Gain Frequency vs Supply Voltage

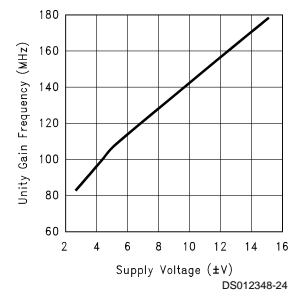

Typical Performance Characteristics $T_A = 25^\circ\text{C}$, $R_L = 1\text{ M}\Omega$, unless otherwise specified (Continued)

GBWP @ 10 MHz vs Supply Voltage

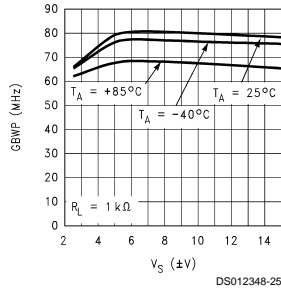

Large Signal Voltage Gain vs Load, $V_S = \pm 15\text{V}$

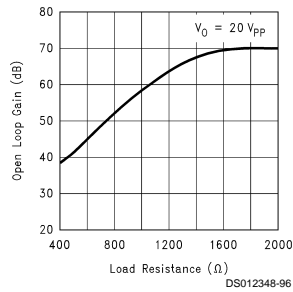

Large Signal Voltage Gain vs Load, $V_S = \pm 5\text{V}$

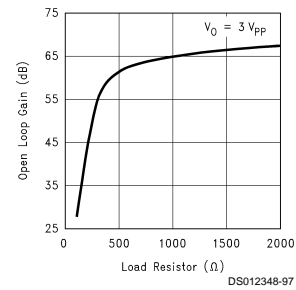

Input Voltage Noise vs Frequency

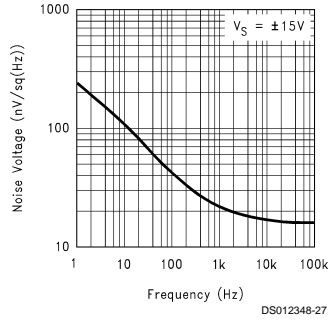

Input Current Noise vs Frequency

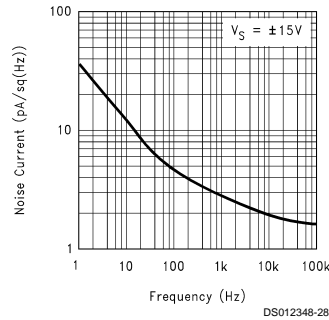

Input Voltage Noise vs Frequency

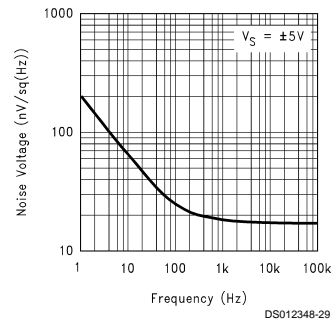

Input Current Noise vs Frequency

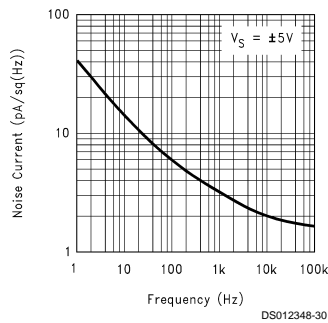

Slew Rate vs Supply Voltage

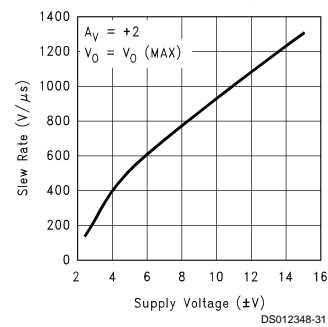

Slew Rate vs Input Voltage

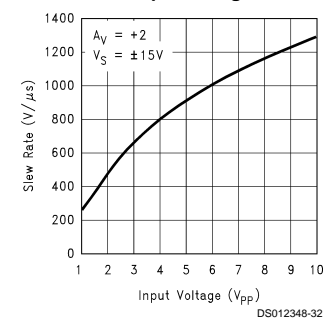

Typical Performance Characteristics $T_A = 25^\circ\text{C}$, $R_L = 1\text{ M}\Omega$. unless otherwise specified (Continued)

Slew Rate vs Input Voltage

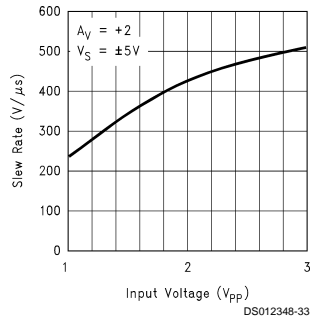

Slew Rate vs Load Capacitance

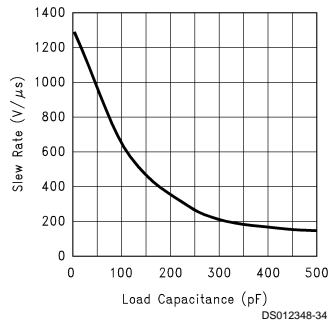

Large Signal Pulse Response, $A_V = -1$, $V_S = \pm 15\text{V}$

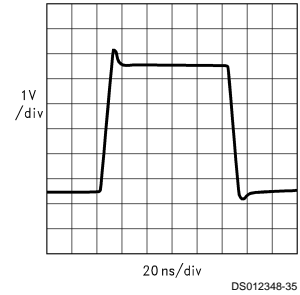

Large Signal Pulse Response, $A_V = -1$, $V_S = \pm 5\text{V}$

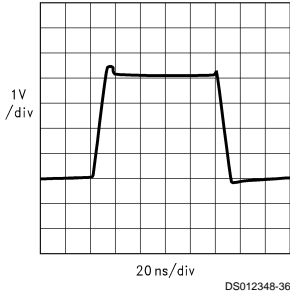

Large Signal Pulse Response, $A_V = -1$, $V_S = +5\text{V}$

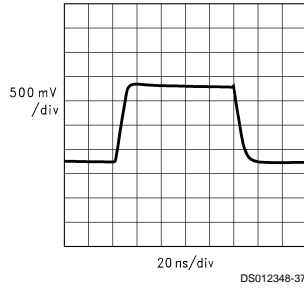

Large Signal Pulse Response, $A_V = +1$, $V_S = \pm 15\text{V}$

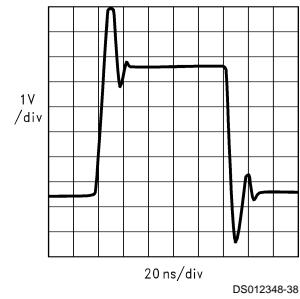

Large Signal Pulse Response, $A_V = +1$, $V_S = \pm 5\text{V}$

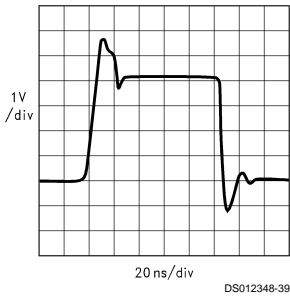

Large Signal Pulse Response, $A_V = +1$, $V_S = +5\text{V}$

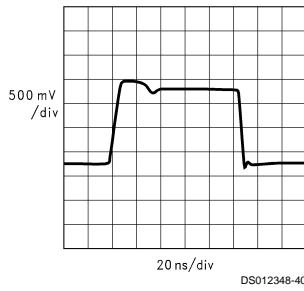

Large Signal Pulse Response, $A_V = +2$, $V_S = \pm 15\text{V}$

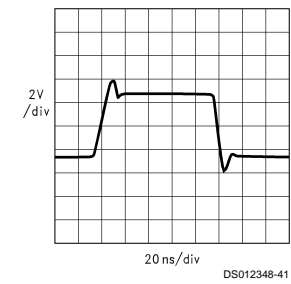

Typical Performance Characteristics $T_A = 25^\circ\text{C}$, $R_L = 1\text{ M}\Omega$. unless otherwise specified (Continued)

Large Signal Pulse Response,
 $A_V = +2$, $V_S = \pm 5\text{V}$

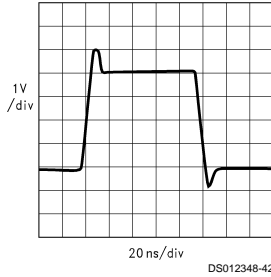

Large Signal Pulse Response,
 $A_V = +2$, $V_S = +5\text{V}$

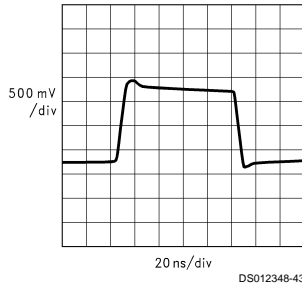

Small Signal Pulse Response,
 $A_V = -1$, $V_S = \pm 15\text{V}$, $R_L = 100\Omega$

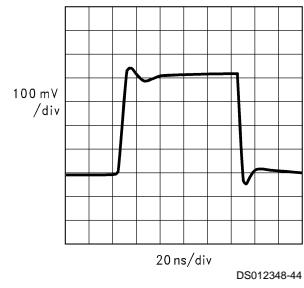

Small Signal Pulse Response,
 $A_V = -1$, $V_S = \pm 5\text{V}$,
 $R_L = 100\Omega$

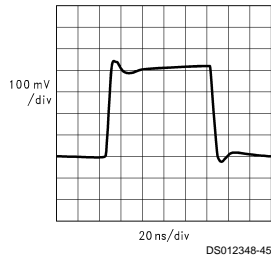

Small Signal Pulse Response,
 $A_V = -1$, $V_S = +5\text{V}$,
 $R_L = 100\Omega$

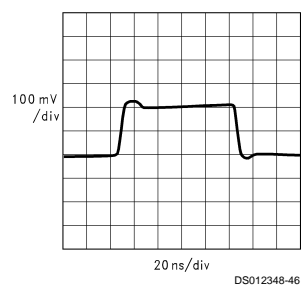

Small Signal Pulse Response,
 $A_V = +1$, $V_S = \pm 15\text{V}$,
 $R_L = 100\Omega$

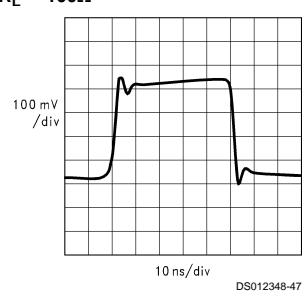

Small Signal Pulse Response,
 $A_V = +1$, $V_S = \pm 5\text{V}$,
 $R_L = 100\Omega$

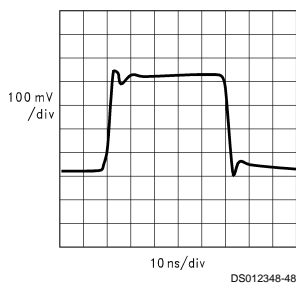

Small Signal Pulse Response,
 $A_V = +1$, $V_S = +5\text{V}$,
 $R_L = 100\Omega$

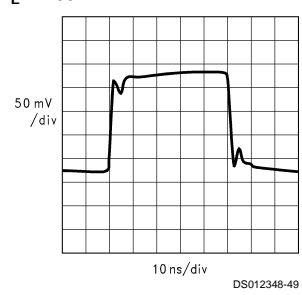

Small Signal Pulse Response,
 $A_V = +2$, $V_S = \pm 15\text{V}$,
 $R_L = 100\Omega$

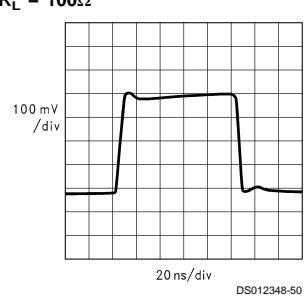

Typical Performance Characteristics $T_A = 25^\circ\text{C}$, $R_L = 1\text{ M}\Omega$. unless otherwise specified (Continued)

Small Signal Pulse Response,
 $A_V = +2$, $V_S = \pm 5\text{V}$,
 $R_L = 100\Omega$

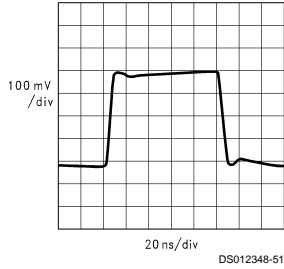

Small Signal Pulse Response,
 $A_V = +2$, $V_S = +5\text{V}$,
 $R_L = 100\Omega$

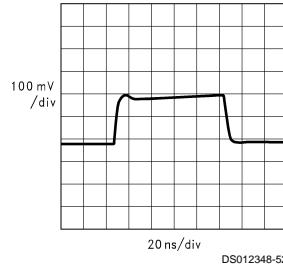

Closed Loop Frequency Response vs Temperature
 $V_S = \pm 15\text{V}$, $A_V = +1$, $R_L = 100\Omega$

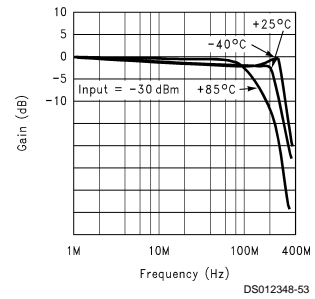

Closed Loop Frequency Response vs Temperature
 $V_S = \pm 5\text{V}$, $A_V = +1$, $R_L = 100\Omega$

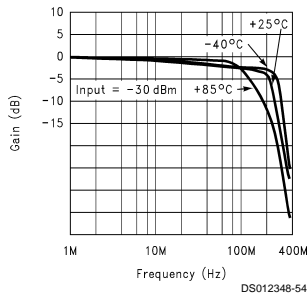

Closed Loop Frequency Response vs Temperature
 $V_S = +5\text{V}$, $A_V = +1$, $R_L = 100\Omega$

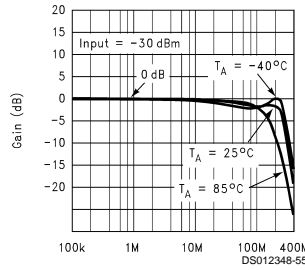

Closed Loop Frequency Response vs Temperature
 $V_S = \pm 15\text{V}$, $A_V = +2$, $R_L = 100\Omega$

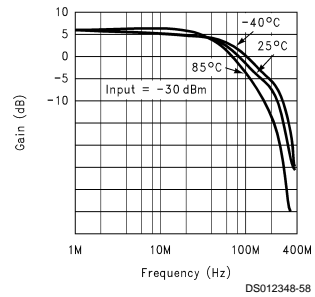

Closed Loop Frequency Response vs Temperature
 $V_S = \pm 5\text{V}$, $A_V = +2$, $R_L = 100\Omega$

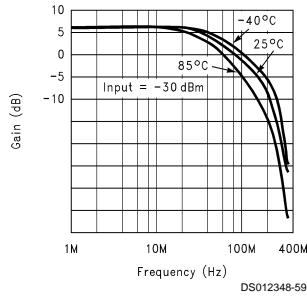

Closed Loop Frequency Response vs Temperature
 $V_S = +5\text{V}$, $A_V = +2$, $R_L = 100\Omega$

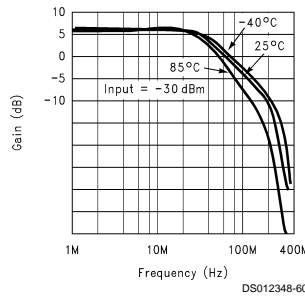

Closed Loop Frequency Response vs Capacitive Load
 $A_V = +1$, $V_S = \pm 15\text{V}$

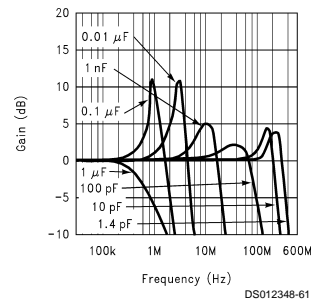

Typical Performance Characteristics $T_A = 25^\circ\text{C}$, $R_L = 1\text{ M}\Omega$. unless otherwise specified (Continued)

Closed Loop Frequency Response vs Capacitive Load ($A_V = +1$, $V_S = \pm 5\text{V}$)

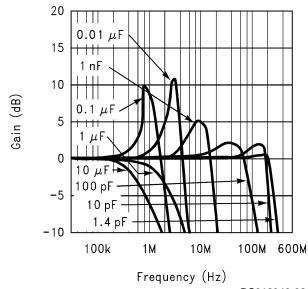

DS012348-62

Closed Loop Frequency Response vs Capacitive Load ($A_V = +2$, $V_S = \pm 15\text{V}$)

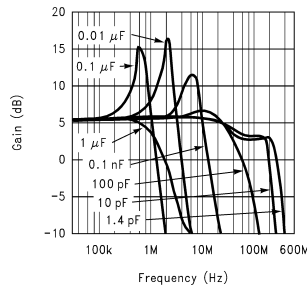

DS012348-63

Closed Loop Frequency Response vs Capacitive Load ($A_V = +2$, $V_S = \pm 5\text{V}$)

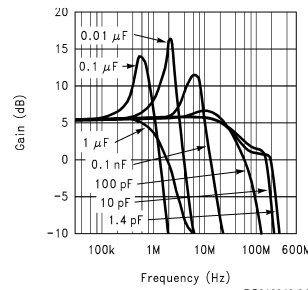

DS012348-64

Total Harmonic Distortion vs Frequency

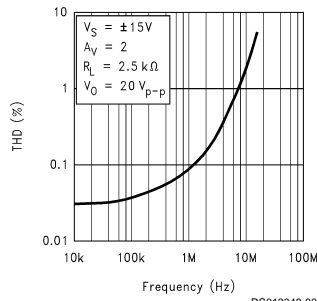

DS012348-80

Total Harmonic Distortion vs Frequency

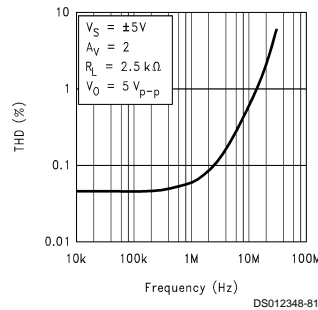

DS012348-81

Total Harmonic Distortion vs Frequency

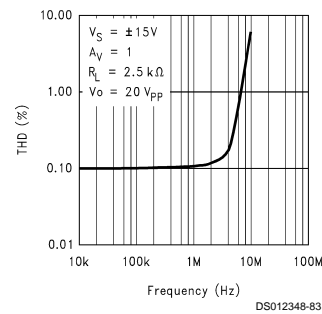

DS012348-83

Total Harmonic Distortion vs Frequency

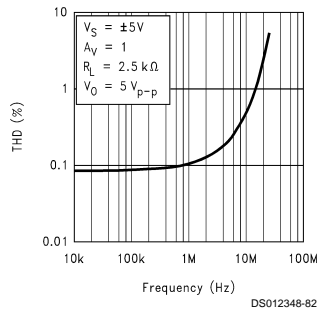

DS012348-82

Undistorted Output Swing vs Frequency

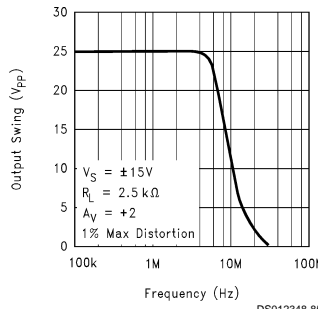

DS012348-85

Undistorted Output Swing vs Frequency

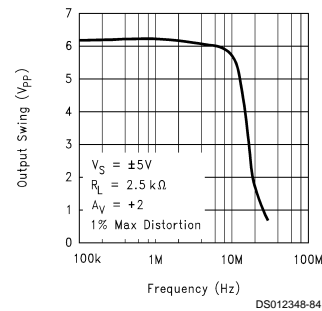

DS012348-84

Typical Performance Characteristics $T_A = 25^\circ\text{C}$, $R_L = 1\text{ M}\Omega$, unless otherwise specified (Continued)

Undistorted Output Swing vs Frequency

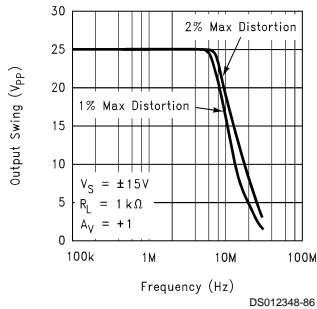

Total Power Dissipation vs Ambient Temperature

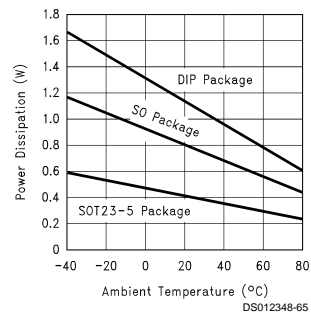

Application Information

The table below, depicts the maximum operating supply voltage for each package type:

TABLE 1. Maximum Supply Voltage Values

	SOT23-5	SO-8
Single Supply	10V	30V
Dual Supplies	±5V	±15V

Stable unity gain operation is possible with supply voltage of 5V for all capacitive loads. This allows the possibility of using the device in portable applications with low supply voltages with minimum components around it.

Above a supply voltage of 6V ($\pm 3\text{V}$ Dual supplies), an additional resistor and capacitor (shown below) should be placed in the feedback path to achieve stability at unity gain over the full temperature range.

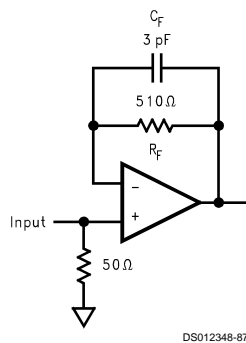

FIGURE 1. Typical Circuit for $A_V = +1$ Operation ($V_S \geq 6\text{V}$)

The package power dissipation should be taken into account when operating at high ambient temperatures and/or high power dissipative conditions. Refer to the power derating curves in the data sheet for each type of package.

In determining maximum operable temperature of the device, make sure the total power dissipation of the device is considered; this includes the power dissipated in the device with a load connected to the output as well as the nominal dissipation of the op amp.

The device is capable of tolerating momentary short circuits from its output to ground but prolonged operation in this mode will damage the device, if the maximum allowed junction temperature is exceeded.

APPLICATION CIRCUITS

Current Boost Circuit

The circuit in Figure 2 can be used to achieve good linearity along with high output current capability.

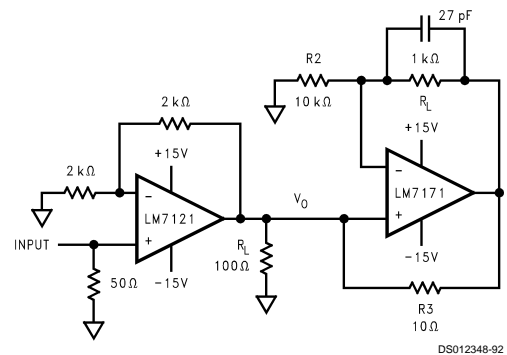

FIGURE 2. Simple Circuit to Improve Linearity and Output Drive Current

By proper choice of R_3 , the LM7121 output can be set to supply a minimal amount of current, thereby improving its output linearity.

R_3 can be adjusted to allow for different loads:

$$R_3 = 0.1 R_L$$

The circuit above has been set for a load of 100Ω .

Reasonable speeds ($<30\text{ ns}$ rise and fall times) can be expected up to 120 mA_{PP} of load current (see Figure 3 for step response across the load).

Application Information (Continued)

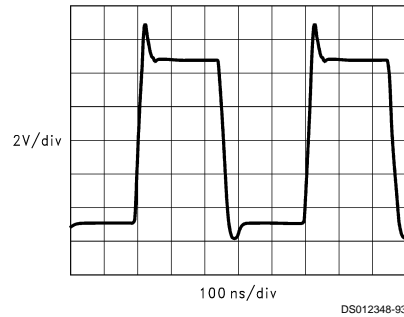

FIGURE 3. Waveform across a 100Ω Load

It is very important to keep the lead lengths to a minimum and to provide a low impedance current path by using a ground-plane on the board.

Caution: If R_L is removed, the current balance at the output of LM7121 would be disturbed and it would have to supply the full amount of load current. This might damage the part if power dissipation limit is exceeded.

Color Video on Twisted Pairs Using Single Supply

The circuit shown in *Figure 4* can be used to drive in excess of 25 meters length of twisted pair cable with no loss of resolution or picture definition when driving a NTSC monitor at the load end.

Application Information (Continued)

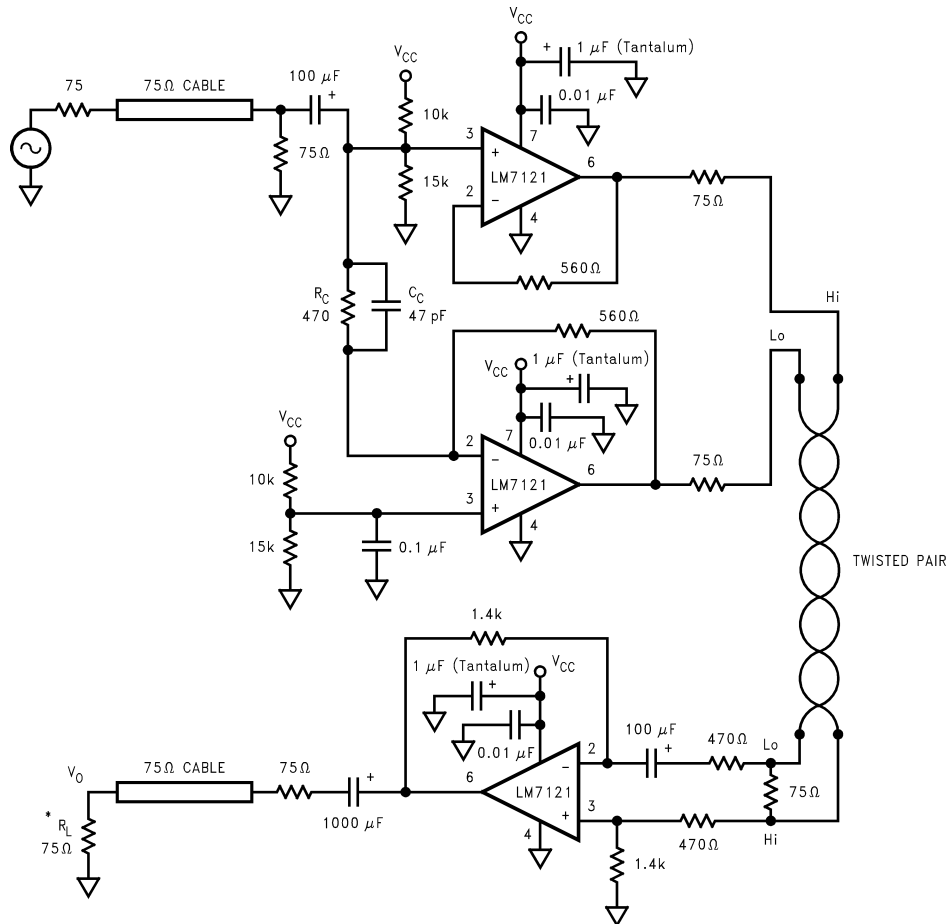

DS012348-94

Note:

Pin numbers shown are for SO-8 package.

*Input termination of NTSC monitor.

FIGURE 4. Single Supply Differential Twisted Pair Cable Transmitter/Receiver
 $8.5V \leq V_{CC} \leq 30V$

Differential Gain and Differential Phase errors measured at the load are less than 1% and 1° respectively.

R_C and C_C can be adjusted for various cable lengths to compensate for the line losses and for proper response at the output. Values shown correspond to a twisted pair cable length of 25 meters with about 3 turns/inch (see Figure 5 for step response).

The supply voltage can vary from 8.5V up to 30V with the output rise and fall times under 12 ns. With the component values shown, the overall gain from the input to the output is about 1.

Even though the transmission line is not terminated in its nominal characteristic impedance of about 600Ω , the resulting reflection at the load is only about 5% of the total signal and in most cases can be neglected. Using 75Ω termination instead, has the advantage of operating at a low impedance and results in a higher realizable bandwidth and signal fidelity.

Application Information (Continued)

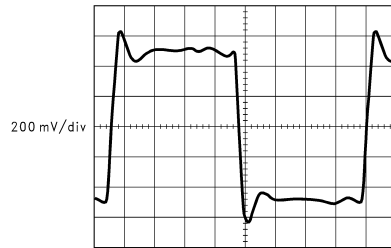

DS012348-95

FIGURE 5. Step Response to a 1 V_{PP} Input Signal Measured across the 75Ω Load

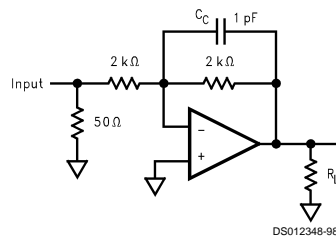

DS012348-98

(a) $A_V = -1$

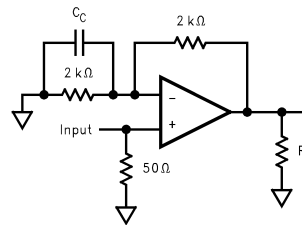

DS012348-99

(b) $A_V = +2$

$C_C = 2 \text{ pF}$ for $R_L = 100\Omega$
 $C_C = \text{Open}$ for $R_L = \text{Open}$

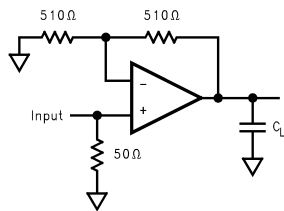

DS012348-A0

(c) $A_V = +2$, Capacitive Load

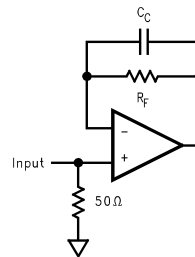

DS012348-A1

(d) $A_V = +1$

$R_F = 0\Omega$, $C_C = \text{Open}$ for $V_S < 6V$
 $R_F = 510\Omega$, $C_C = 3 \text{ pF}$ for $V_S \geq 6V$

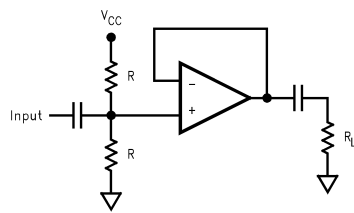

DS012348-A2

(e) $A_V = +1$, $V_S = +5V$, Single Supply Operation

FIGURE 6. Application Test Circuits

Physical Dimensions inches (millimeters) unless otherwise noted

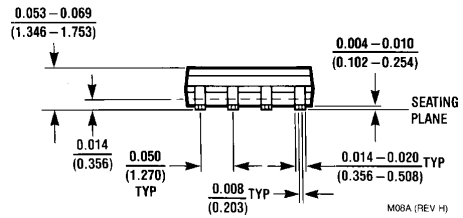
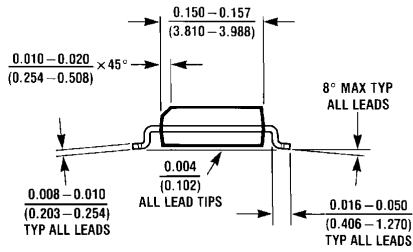
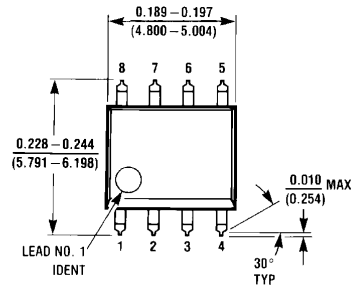

8-Lead (0.150" Wide) Small Outline Package, JEDEC
Order Number LM7121IM or LM7121IMX
NS Package Number M08A

M08A (REV H)

Physical Dimensions inches (millimeters) unless otherwise noted (Continued)

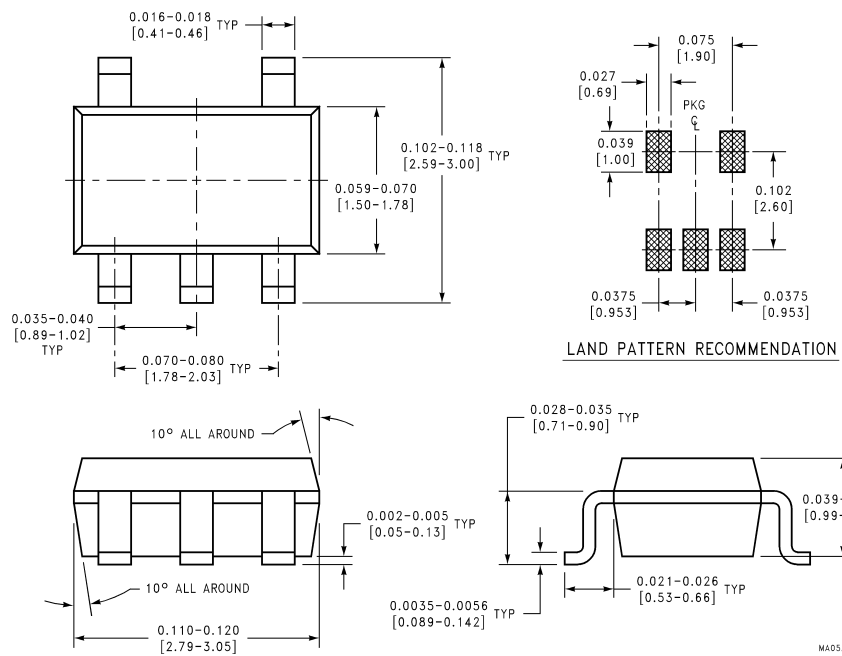

5-Lead Molded SOT23-5
Order Number LM7121IM5 or LM7121IM5X
NS Package Number MA05A

LIFE SUPPORT POLICY

NATIONAL'S PRODUCTS ARE NOT AUTHORIZED FOR USE AS CRITICAL COMPONENTS IN LIFE SUPPORT DEVICES OR SYSTEMS WITHOUT THE EXPRESS WRITTEN APPROVAL OF THE PRESIDENT AND GENERAL COUNSEL OF NATIONAL SEMICONDUCTOR CORPORATION. As used herein:

1. Life support devices or systems are devices or systems which, (a) are intended for surgical implant into the body, or (b) support or sustain life, and whose failure to perform when properly used in accordance with instructions for use provided in the labeling, can be reasonably expected to result in a significant injury to the user.
2. A critical component is any component of a life support device or system whose failure to perform can be reasonably expected to cause the failure of the life support device or system, or to affect its safety or effectiveness.

 <p>National Semiconductor Corporation Americas Tel: 1-800-272-9959 Fax: 1-800-737-7018 Email: support@nsc.com www.national.com</p>	<p>National Semiconductor Europe Fax: +49 (0) 1 80-530 85 86 Email: europe.support@nsc.com Deutsch Tel: +49 (0) 1 80-530 85 85 English Tel: +49 (0) 1 80-532 78 32 Français Tel: +49 (0) 1 80-532 93 58 Italiano Tel: +49 (0) 1 80-534 16 80</p>	<p>National Semiconductor Asia Pacific Customer Response Group Tel: 65-2544466 Fax: 65-2504466 Email: sea.support@nsc.com</p>	<p>National Semiconductor Japan Ltd. Tel: 81-3-5639-7560 Fax: 81-3-5639-7507</p>
--	---	---	---

National does not assume any responsibility for use of any circuitry described, no circuit patent licenses are implied and National reserves the right at any time without notice to change said circuitry and specifications.